

UTOPECO



SPC Flooring

Contact

WhatsApp: +86 13191878999

Website: www.utopeco.com

E-mail: aaron@bestspcfloor.com

Phone/WeChat: +86 13191878999

Welcome

Hebei UTOP Technologies Co., Ltd.

Room 1006, Financial Building, NO.598 Zhongshan East Road,
Shijiazhuang, Hebei, China.



Website



www.utopeco.com



CONTENTS

- ... About UTOP
- ... What is SPC Flooring
- ... What is LVT Flooring
- ... SPC /LVT Color Options
- ... Herringbone SPC Flooring
- ... Company Qualifications
- ... Skirting and Accessories

About UTOP

As an up-rising star of SPC flooring producer & supplier, Hebei UTOP Technologies Co., Ltd. is a professional vinyl flooring manufacturer integrating production, research and sales. We are one of the first batch of manufacturer to introduce international advanced SPC production lines.

We have 10 production lines including extrusion lines, UV coating lines, cutting lines, slotting lines, padding lines and packing lines to cover the whole business chain from the beginning to the end. In addition, we have over 200 skillful workers that can run machines smoothly and produce 20,000 square meters per day.

We are keen to developing and researching advanced technologies and launching new products to follow market and industry trends and satisfy more customers' demands. Our products are exported to more than 50 countries and regions, for example, United States, Canada, Australia, Peru, Germany, Malaysia, Vietnam, Thailand, Greece, Colombia, Kenya and India. Welcome to visit us!



10
PRODUCTION
LINES

100+M²
WORKSHOP

20,000 M²
DAILY CAPACITY

5
QUALITY
INSPECTION

300+
COLOR RANGES

24H
SERVICE

100%
CUSTOMER
SATISFACTION

10000
CLASSICAL
PROJECTS

0
FREE SAMPLE

We are and will always be continuously improve technology and research new products to serve customer better

What is SPC Flooring

STRUCTURE & FUNCTIONS

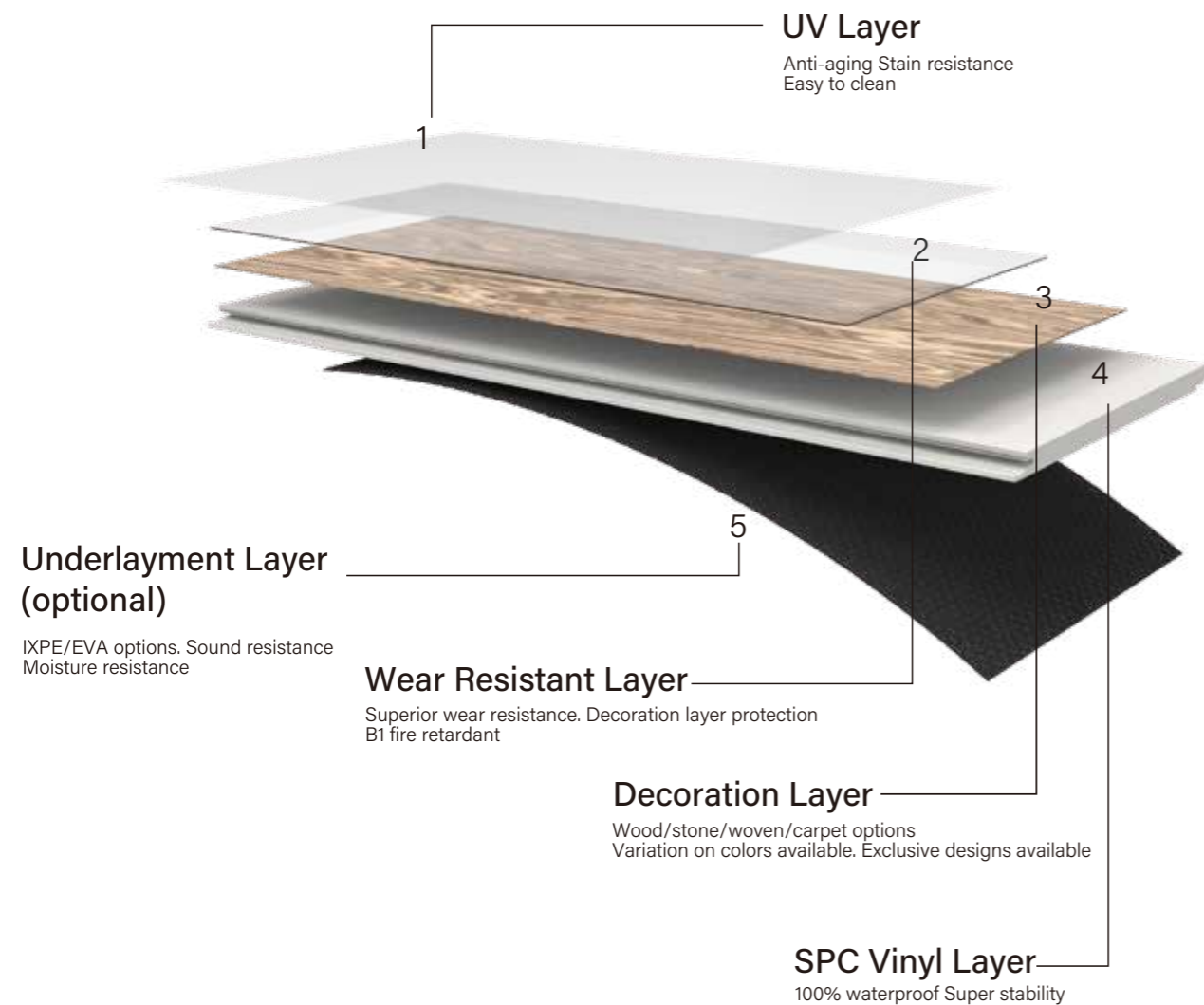

- With Underlayment
- Without Underlayment

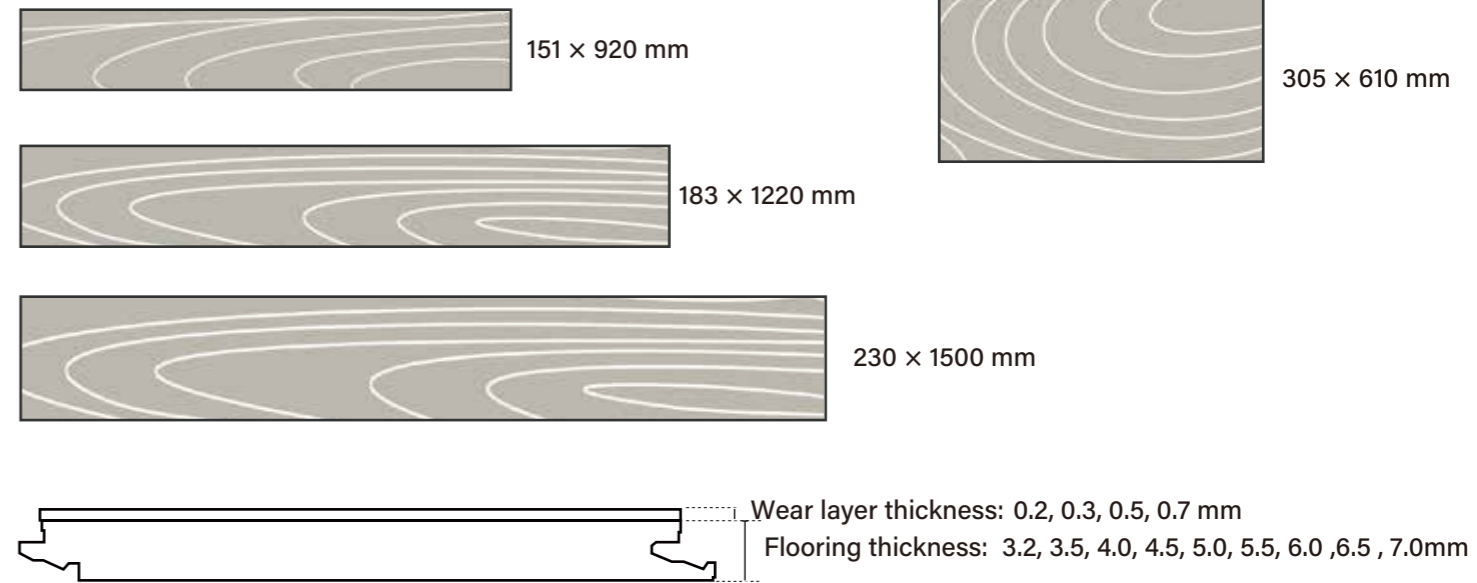

DETAILED PARAMETERS

Item	Detection Result	Detection Method	
Dimension	151 x 920 mm;183 x 1220 mm;230 x 1500 mm;305 x 610 mm	EN 427	✓
Thickness in total	3.2-12 mm	EN 428	✓
Thickness of wear layers	0.1-0.7 mm	EN 429	✓
Peeling strength of layers	Pass	EN 431	✓
Shearing force of layers	Good	EN 432	✓
Residual indentation after static load	Mean value 0.01 mm	EN 433	✓
Dimension stability	Shrinkage ≤0.002%; curling ≤0.02 mm	EN 434	✓
Flexibility - 10 mm mandrel	No damage	EN 435	✓
Resistance to chemicals	Class zero	EN 423	✓
Bearing a castor chair	No disturbance, no delamination	EN 425	✓
Color fastness to light	≥6	ISO 105 B02	✓
Wear resistance	Pass	EN 660	✓
Toxic	Complies	EN 71-3	✓
Resistance to fire	NFPA class B		
Slip resistance	R9		
Performance classification	23, 34, 43		
GB/T4085 PVC block material performance testing		Pass	×
GB 8624 B1 grade flammability testing		Pass	×
CNS 8907 anti-flaming testing		Pass	×



INTEGRATES WOOD BEAUTY & EXCEPTIONAL DURABILITY



DURABLE AND EASY TO CLEAN FLOORING



COMBINES STONE BEAUTY & GREAT IMPACT RESISTANCE



Anti-Bacteria



Eco Friendly



100% Waterproof



Fireproof







Stain Resistance



Anti-Slip

SPC FLOORING INSTALLATION & MAINTENANCE

Precautions before installation

-  SPC flooring should be leveled and placed on site with constant temperature and stability for 24 hours before installation;
-  Make sure the subfloor is smooth and clean before installing the flooring, without any residue;
-  When installing the flooring, the indoor temperature should be kept between 15 °C and 28 °C, indoor temperature and surface temperature at 15 °C are recommended. When the temperature is lower than 5 °C or higher than 30 °C, the installation shall not be performed, The relative air humidity suitable for construction should be between 20% and 75%.
-  The moisture content of the base layer shall be less than 3%. The strength of the base layer shall not be lower than the requirement of concrete strength C-20, otherwise suitable self-leveling should be used to strengthen the strength, The surface hardness of the base layer is not less than 1.2 MPa.

INSTALLATION

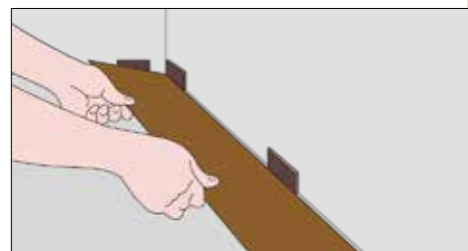

STEP 1

Before installation, it is recommended to spread floor film, which can make better feeling of feet and prevent the noise generated between the ground and the floor by small grains of sand. Put the first floor from the left corner of the room.

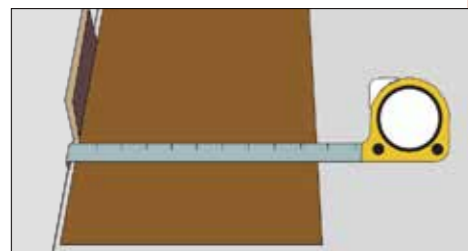

STEP 2

To prevent the natural expansion of the floor, at least 0.4 cm gap should be reserved between the wall and the floor.

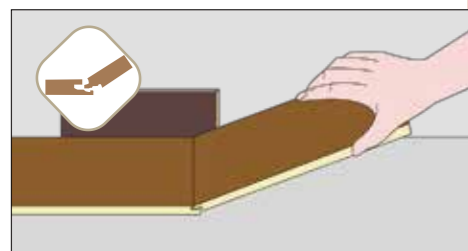

STEP 3

When installing the first and second floor, insert the convex damage of the short side into the groove of the first floor. Continue to use the above method to install other floors.

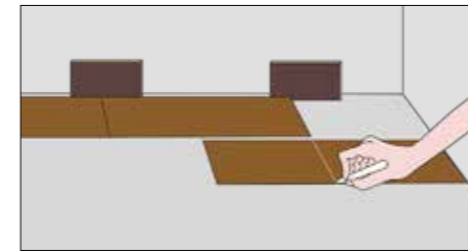

STEP 4

When installing the last piece of the first row, you need to take the remaining part of the floor measurement first, and note that the floor needs to be measured in reverse.

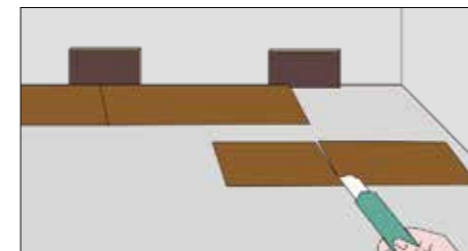

STEP 5

Finally, use the art knife to force the floor surface, break it by hands easily, then install the last floor of the first row.



STEP 6

Start installing the second row. When installing the second floor, insert the convex of the short side into the groove of the previous floor, and gently insert the convex of the long side into the corresponding floor groove.



STEP 7

Use a rubber hammer when there are gaps.



STEP 8

Recommended installation method reference picture.



STEP 9

Finally, the same method can be used to install other floors in the room to ensure that necessary expansion gaps are left between all fixed vertical planes in the room, including doors, walls, cabinets and other fixed objects.

What is LVT Flooring

STRUCTURE & FUNCTIONS

■ Dry back type

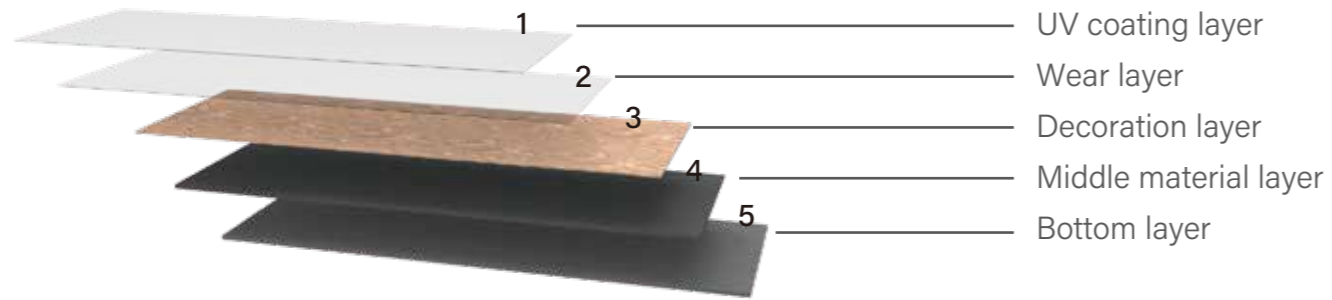

■ Self adhesive type

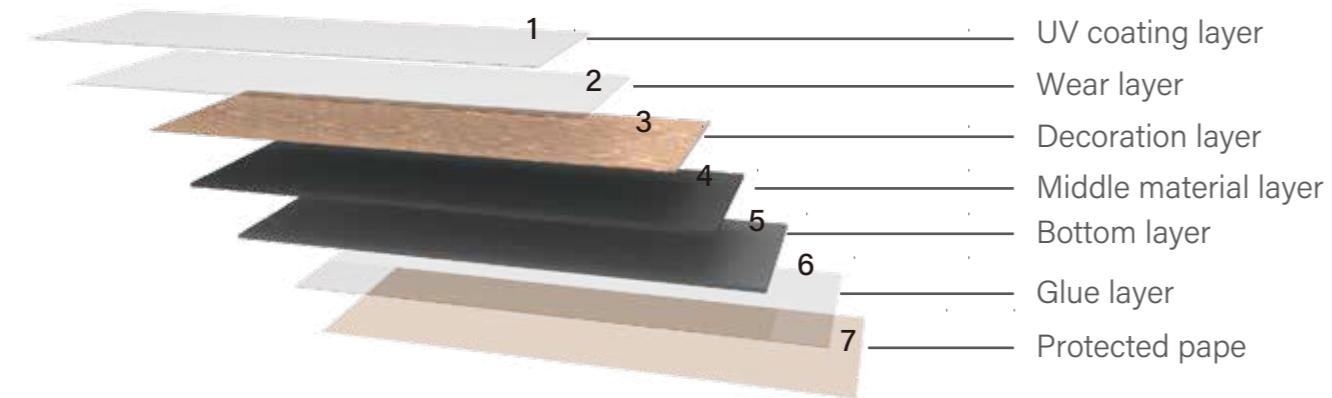

■ Loose lay type

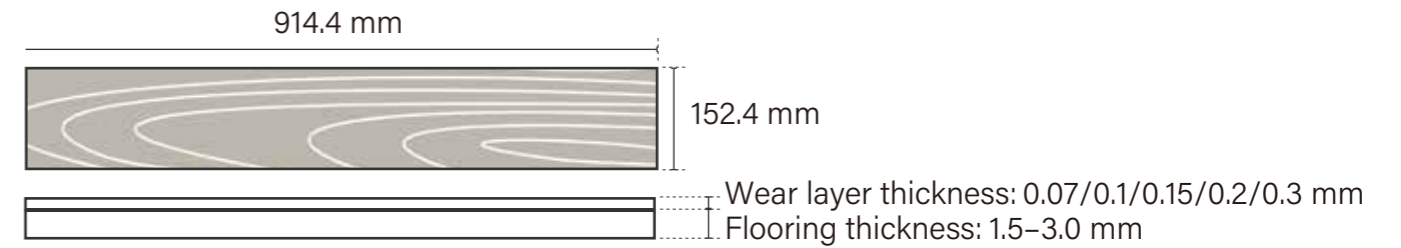
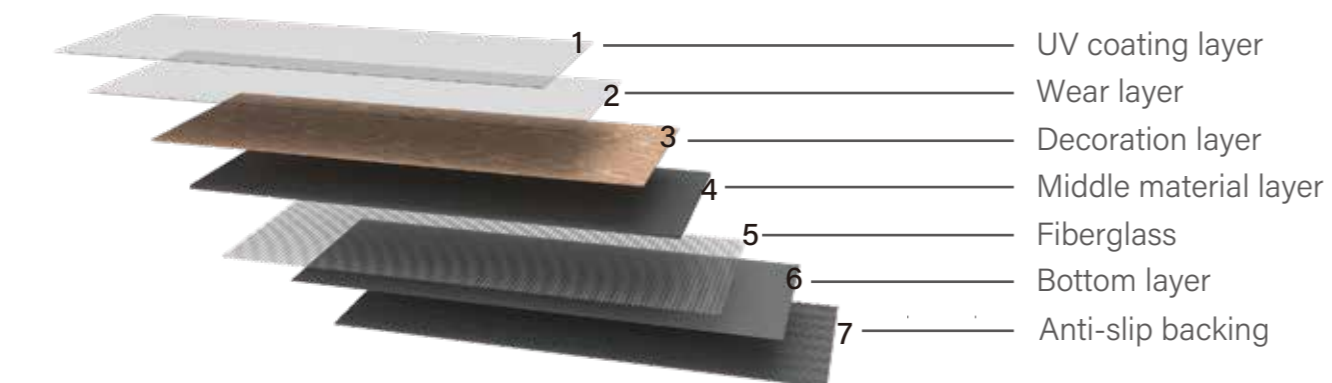

ADVANTAGES

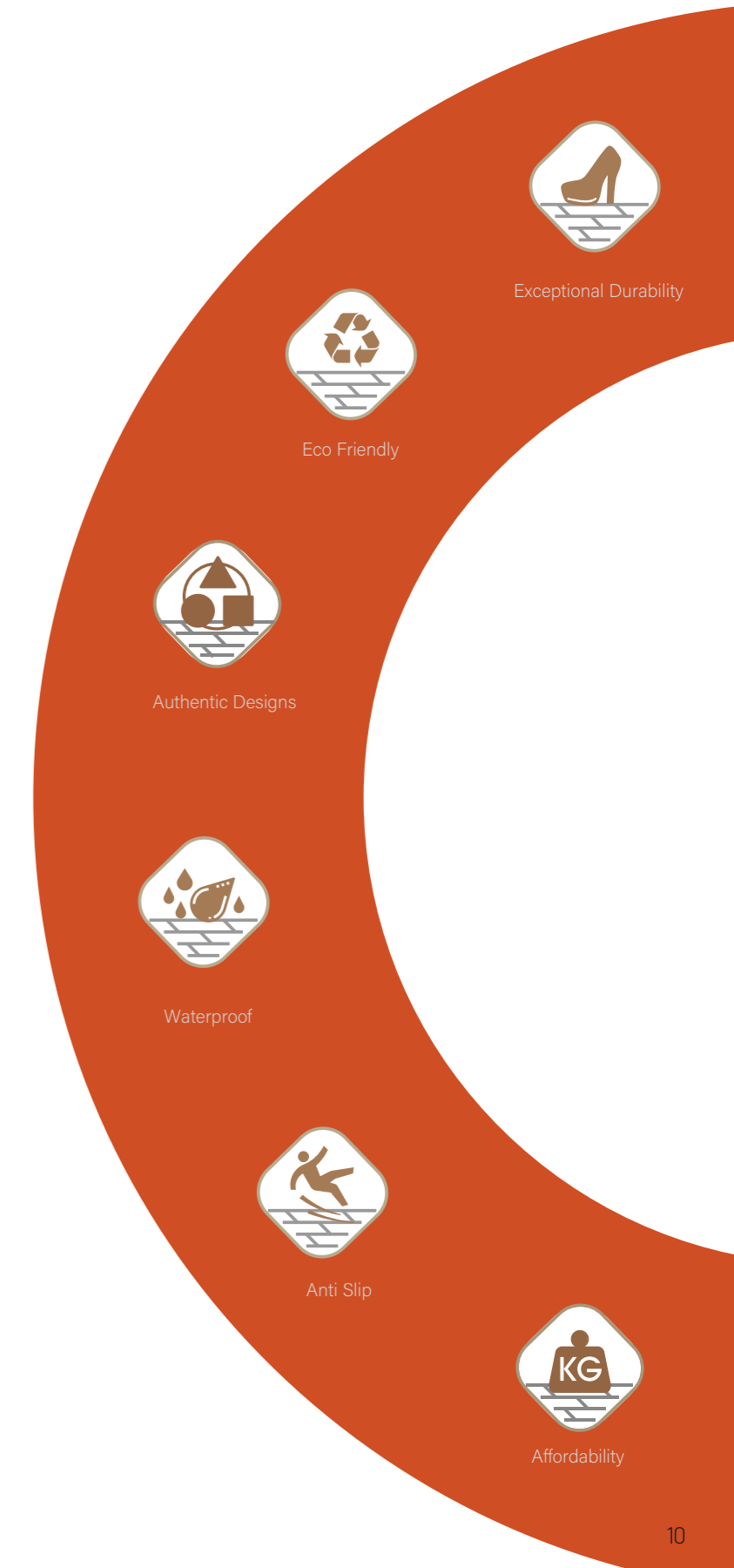

SPC /LVT Flooring Color Options



WOOD LOOK

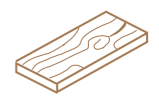

These realistic wood look design comes in many different colors, patterns and surface treatments.



UTOP-1801





UTOP-1916



UTOP-1707

UTOP-1969

UTOP-2158

UTOP-1708

UTOP-1716

UTOP-9901

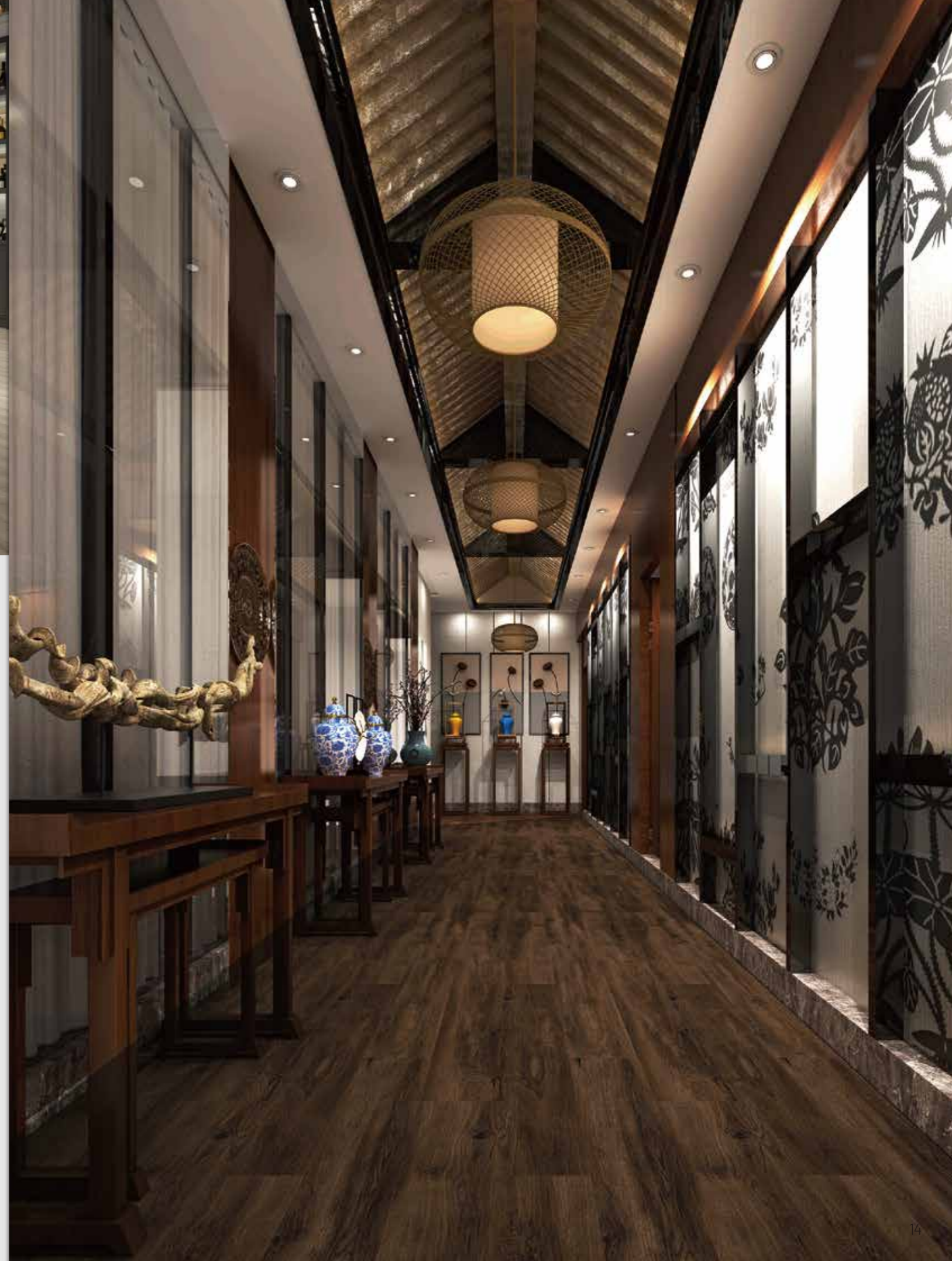



UTOP-2001



UTOP-2002

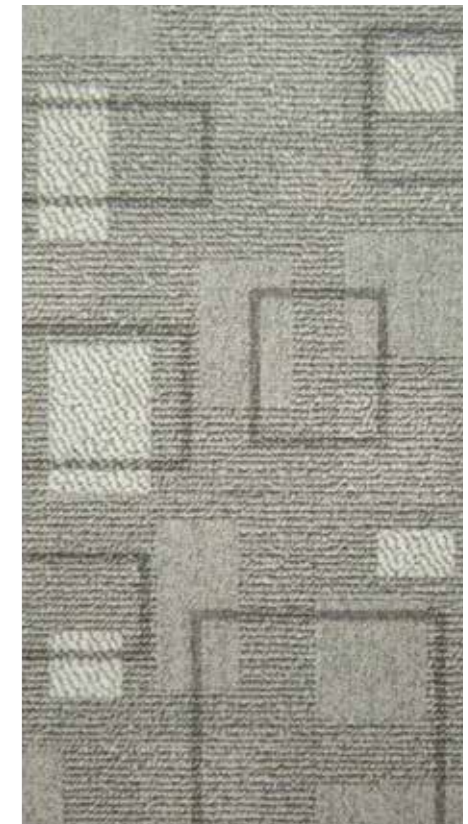

UTOP-2003

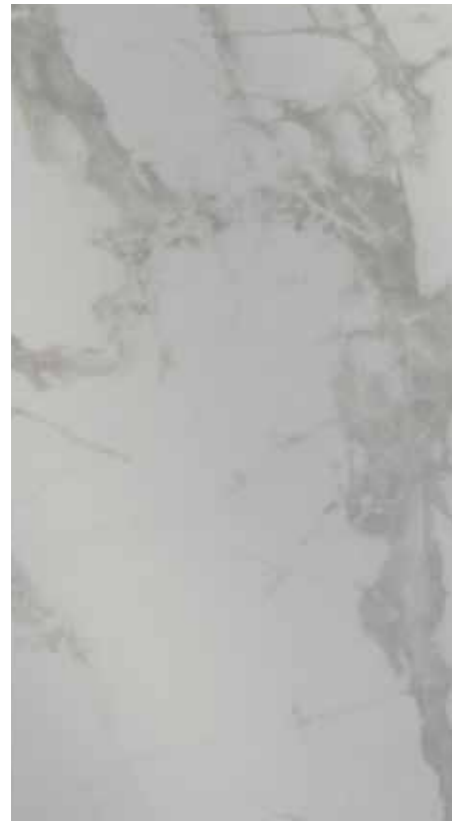

UTOP-9007



UTOP-9016



UTOP-9015





UTOP-8001S-14



UTOP-8001-21



UTOP-8001S-28



UTOP-8005-11



UTOP-8033-1



UTOP-8002S-1

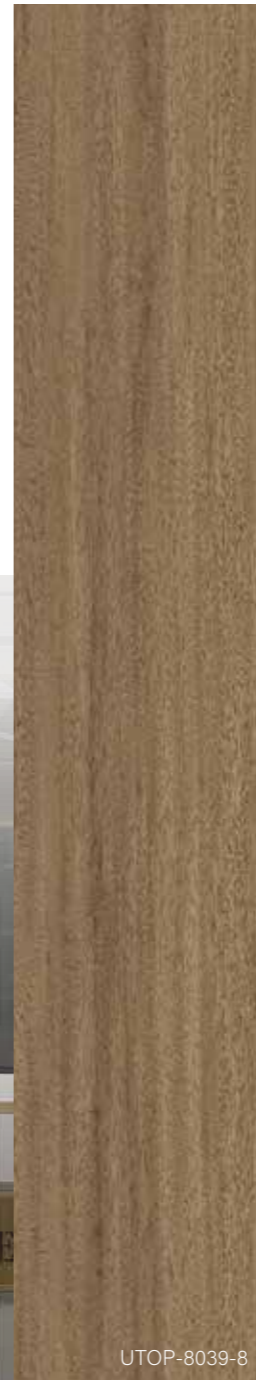

UTOP-8039-8



UTOP-8020-8



UTOP-8069-1



UTOP-8003-39



Herringbone SPC Flooring



HERRINGBONE PATTERN

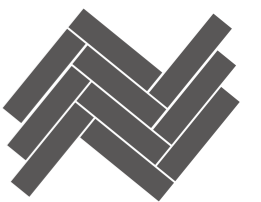
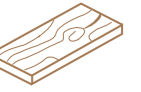

The herringbone pattern flooring creates a classic and elegant visual effect, adding a unique style and charm to the interior space. Its arrangement can enhance the sense of space and visual depth in a room, making it appear more spacious and open.

LVT FLOORING INSTALLATION & MAINTENANCE

Precautions before installation

- ✓ Store the unopened boxes in the room where the LVT flooring is to be installed for at least 48 hours before installation.
- ✓ Always store the boxes on a flat and level surface.
- ✓ Heating and air conditioning should be operational and set between 18 °C and 29 *C before, during and after installation.
- ✓ Remove thresholds and baseboards before you measure the room and calculate how much flooring to purchase.
- ✓ Remove the existing flooring to access to the subfloor if necessary.
- ✓ Use a patching compound to fill in all cracks and holes in your subfloor to get a smooth, even subfloor surface.
- ✓ Sweep the subfloor to make sure it is free from free of dust, stain and other contaminants.

INSTALLATION

■ Self-Adhesive LVT Flooring



STEP 1

Use a tape ruler to measure the length and width of the room and determine the center of the room.



STEP 2

Snap chalk lines through the center of the room and divide the room into 4 equal sections.

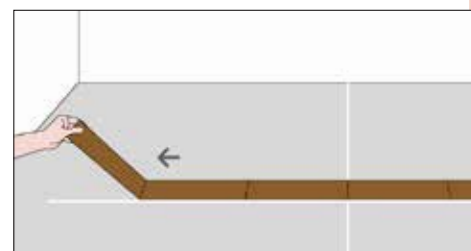

STEP 3

Lay a row of LVT flooring planks on the longest chalk line to see how they fit.

LVT FLOORING INSTALLATION & MAINTENANCE

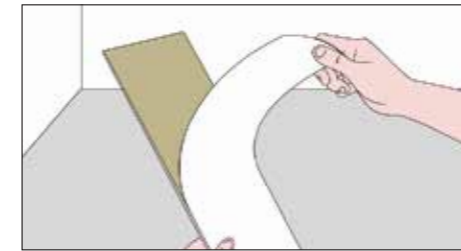

STEP 4

Flip the first plank over and grab the corner of the backing paper. Slowly peel the backing paper off of the first plank and throw it into the bin.

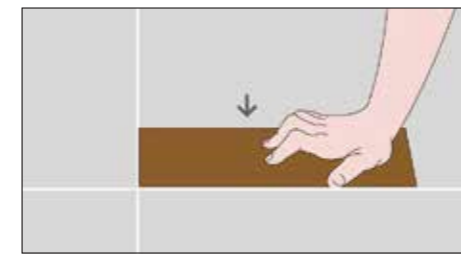

STEP 5

Flip the plank over and make sure the patterned side is face-up. Align the plank and make the plank flush against one of the corners where the chalk lines intersect.



STEP 6

Line up the short ends of planks and ensure the long edges are flush with one another. Press the second plank into place and continue to add more planks.

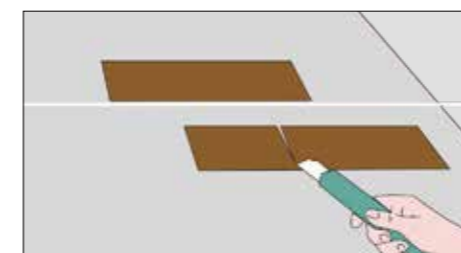

STEP 7

Measure the distance from the end of the last plank in the row to the wall. Cut the plank into the measured size. Install the cut plank on the end of the first row and make sure the cut edge is against the wall.

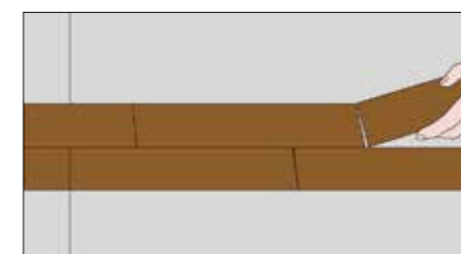

STEP 8

Move the first plank of your second row and make 1/2 or 1/3 of its length offset from the end of one of the planks in your first row. Stagger the rows of planks, offset the ends of each plank to hide the seams better.

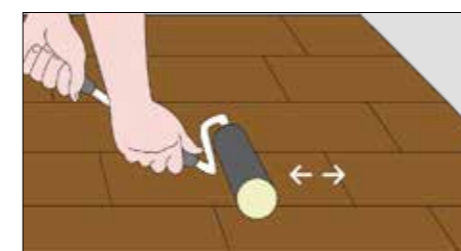

STEP 9

When the installation is finished, flatten the planks with a floor roller. Press the roller onto the planks and walk it across the length of the room to make sure planks are firmly adhered to the subfloor.

LVT FLOORING INSTALLATION & MAINTENANCE

Precautions before installation

INSTALLATION

■ Dry Back LVT Flooring

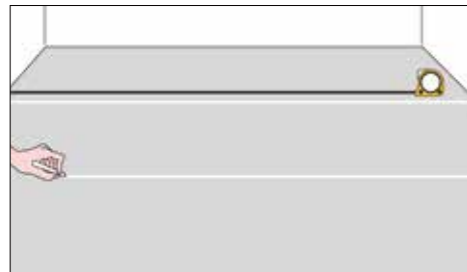

STEP 1

Measure the length and width of the room accurately and calculate an even distribution of the first and last rows. Then draw a starting line on the floor with a chalk line.

1



STEP 2

Spread the adhesive along the starting line. Use the correct opening time and processing time. Place the planks exactly along the perfectly straight starting line.

2

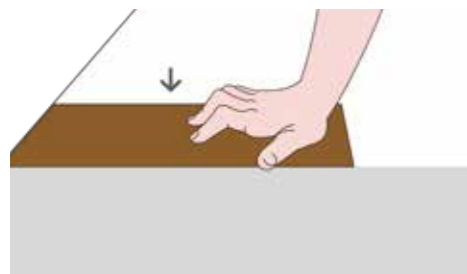

STEP 3

Starting from one side of the straight line, press the planks onto the floor. Moving towards the other side of the wall and continue to add more planks.

3



STEP 4

Measure the distance from the end of the last plank in the row to the wall. Cut the plank into the measured size. Lay the cut part and make sure the cut edge is against the wall.

4

LVT FLOORING INSTALLATION & MAINTENANCE

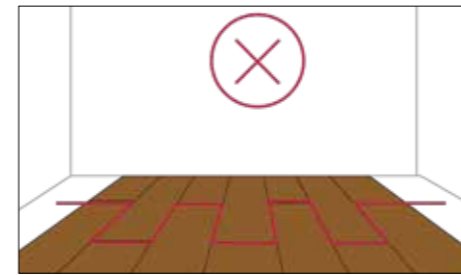

STEP 5

For a natural look, we recommend that the piece left over from the first row should not be used as the first piece of the second row to avoid creating a kind of stair case effect.

5

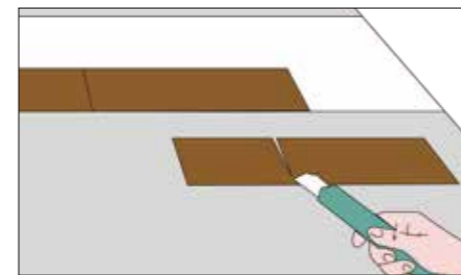

STEP 6

For the second and every subsequent row, make sure to stagger the end joints a minimum of 30 cm apart from the previous row.

6

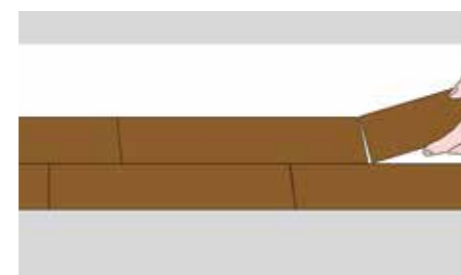

STEP 7

Place the second and each subsequent row and make sure there are no gaps between the planks.

7



STEP 8

Cut the last row along the wall or any obstacle with a utility knife. Remove any adhesive residues on the surface of the floor.

8



STEP 9

When the installation is finished, use a floor roller to ensure all the planks are firmly bonded to the floor.

9

LVT FLOORING INSTALLATION & MAINTENANCE

Precautions before installation

- ✓ Store the unopened boxes in the room where the LVT flooring is to be installed for at least 48 hours before installation.
- ✓ Always store the boxes on a flat and level surface.
- ✓ Heating and air conditioning should be operational and set between 18 °C and 29 °C before, during and after installation.
- ✓ Remove thresholds and baseboards before you measure the room and calculate how much flooring to purchase.
- ✓ Remove the existing flooring to access to the subfloor if necessary.
- ✓ Use a patching compound to fill in all cracks and holes in your subfloor to get a smooth, even subfloor surface.
- ✓ Sweep the subfloor to make sure it is free from free of dust, stain and other contaminants.

INSTALLATION

■ Loose Lay LVT Flooring

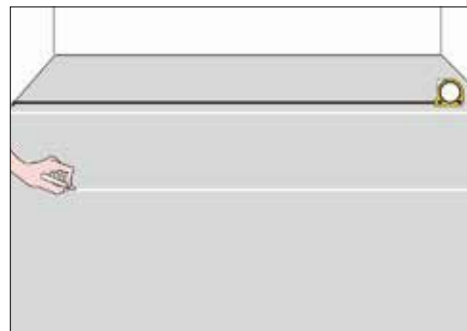

STEP 1

Accurately measure the length and width of the room and calculate the even distribution for the first and last rows. Then, draw a starting line on the floor with chalk.

1

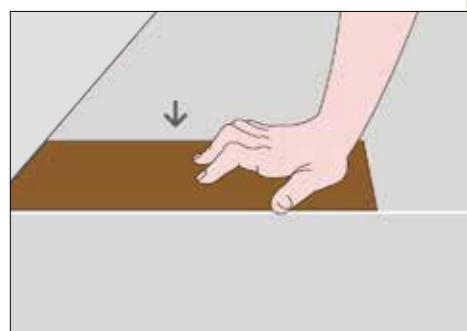

STEP 2

Moving towards the other side of the wall and continue to add more planks.

2

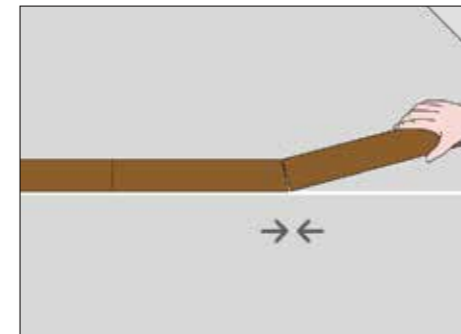

STEP 3

Line up the short ends of planks and ensure the long edges are flush with one another. Press the second plank into place and continue to add more planks.

3

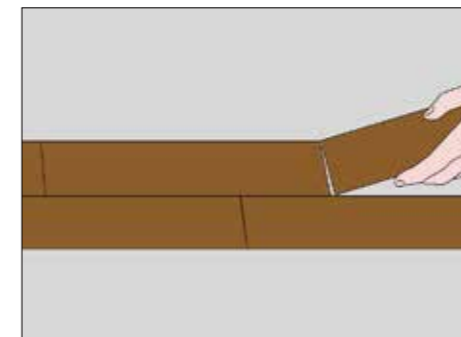

STEP 4

Place the second and each subsequent row and make sure there are no gaps between the planks.

4



STEP 5

Repeat this process until you reach the edge row. Mark a line to determine the appropriate width of the flooring and cut it to fit tightly. When installing the edge row, cut the width according to the remaining space and install it.

5

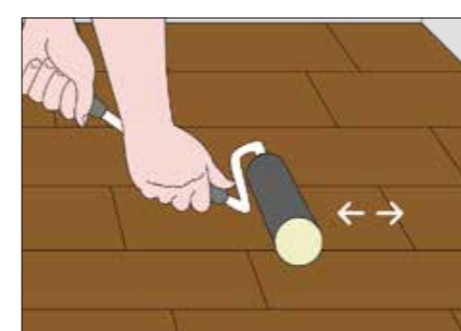

STEP 6

When the installation is finished, use a floor roller to ensure all the planks are firmly bonded to the floor.

6



100% WATERPROOF



WEAR-RESISTANT

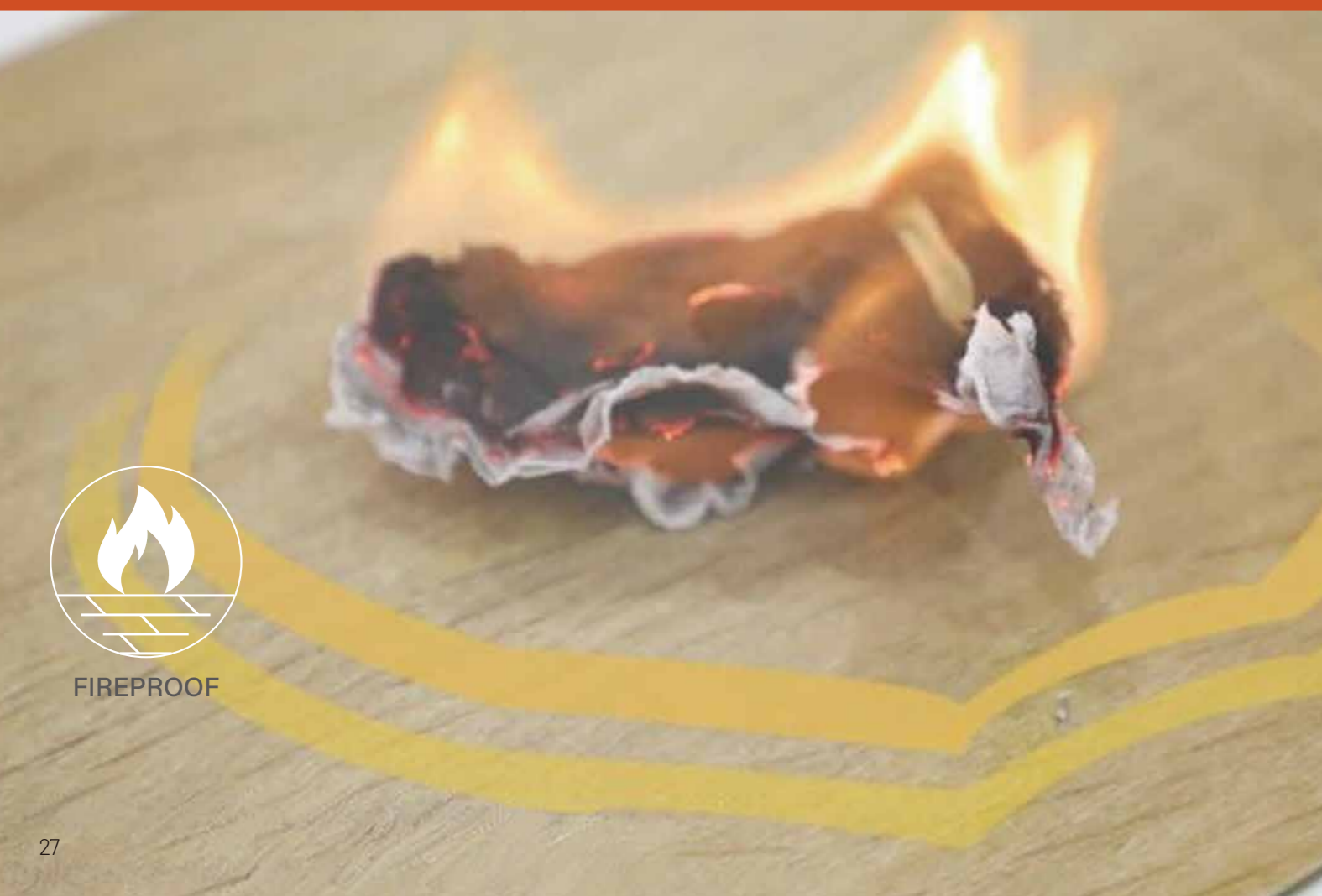

FIREPROOF

Company Qualifications

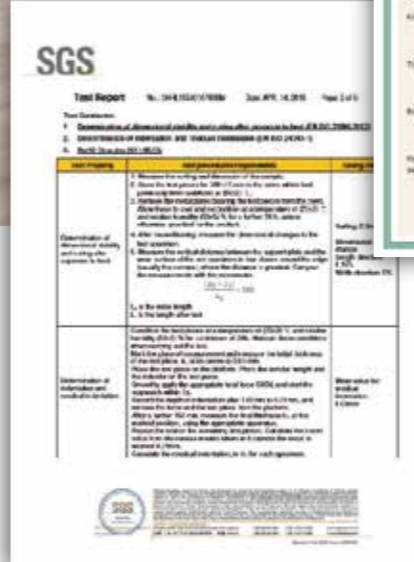



SPC Flooring

has a wide range of applications

COMMERCIAL AND RESIDENTIAL



HOUSE



HOTEL



OFFICE



SCHOOL



HOSPITAL



Kindergarten

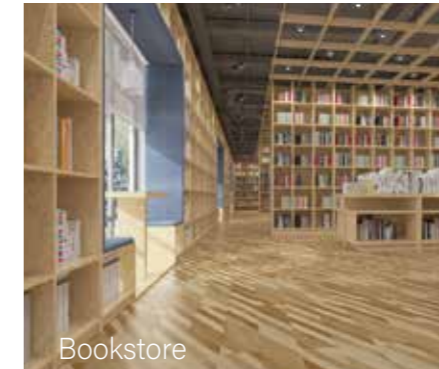

Bookstore



Hospital

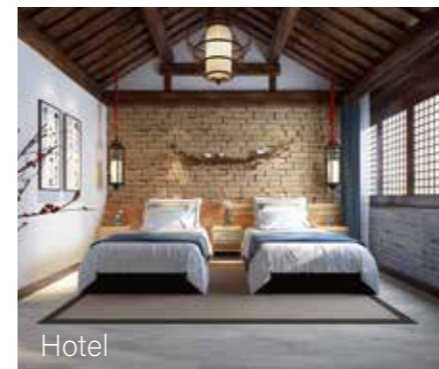

Hotel

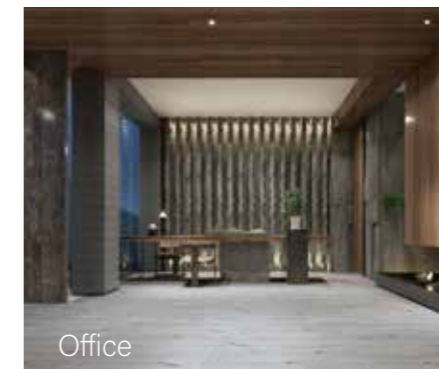

Office

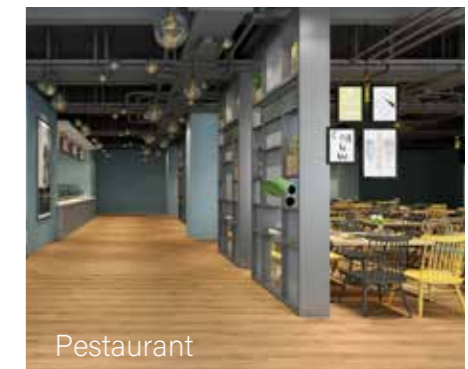

Restaurant



















Living room

The wide applicability of SPC flooring stems from its outstanding performance characteristics, including wear resistance, waterproofing, ease of cleaning, durability, and comfort. This makes it a popular choice for various flooring needs.

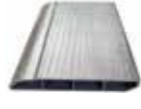
SKIRTING AND ACCESSORIES

SPC SERIES

	T-MOULDING Size 2400x45x6 mm		REDUCER Size 2400x45x8 mm		END CAP Size 2400x35x8 mm
	Multi Function Molding Size 2400x50x7 mm		STAIR NOSE A Size 2400x55x18 mm		STAIR NOSE B Size 2400x72x25 mm
	STAIR BOARD R Size 2400x115x24 mm		STAIR BOARD L-B Size 2400x110x33 mm		SKIRTING 60 Size 2400x60x12 mm
	SKIRTING 60 Size 2400x60x15 mm		QUARTER ROUND Size 2400x28x15 mm		SKIRTING 80-1 Size 2400x80x15 mm
	SCOTIA Size 2400x28x15 mm		SKIRTING 80 Size 2400x80x12 mm		SKIRTING 75 Size 2400x75x12 mm
	STAIR NOSE C Size 2400x75x24 mm		U-TRACK (plastic) Size 2400x14x6 mm		

SKIRTING AND ACCESSORIES

PVC SERIES

	REDUCER-A Size 2400x30x6 mm		L-LINE B Size 2400x20x10 mm		L-LINE A Size 2400x24x15 mm
	STAIR NOSE B Size 2400x50x26 mm		L-LINE A-1 Size 2400x24x4 mm		U-TRACK (plastic) Size 2400x14x6 mm
	L-LINE B-1 Size 2400x20x4 mm		T-MOULDING Size 2400x35x7 mm		

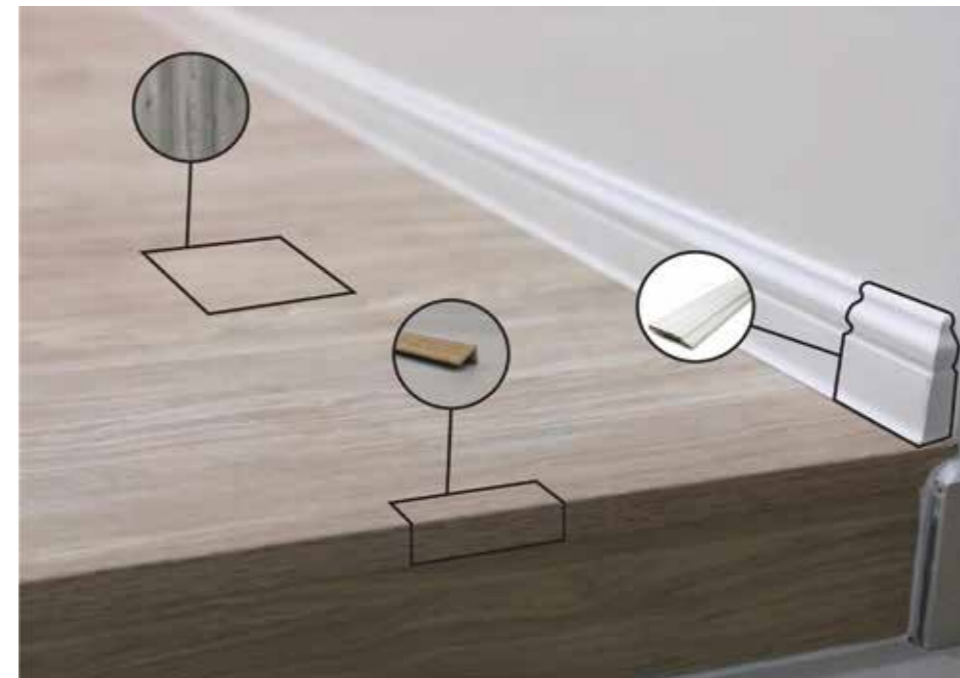

FLOORING ACCESSORIES

Flooring accessories are an essential part of every flooring project as every floor needs accessories of one sort or another to perfectly fit your selection of flooring and give a stunning effect for your project. We can offer all kinds of accessories you need to ensure your new floor goes down with style.



TENSILE STRENGTH TEST

Exporter and Direct manufacturer

During the production, we take several samples from each batch of products and carry out random testing.

Typically, our carry out the following inspections and tests to ensure that every batch of products are qualified and in compliance with international standards and customer requirements.



THICKNESS INSPECTION



SCRATCH RESISTANCE TEST

Choose UTOP, UR TOP Choice.

